

PFA131

Junction Box



Features

- Material: Aluminum & SECC
- Junction Box
- Neat & Integrated design

Specifications

Model	PFA131
General	
Material	Aluminum & SECC
Product Dimension	φ138mm x 42mm
Pipe Thread	M20(G1/2")
Operating Temperature	-40°C ~60°C
Humidity	0~90% RH
Load Bearing	3.0Kg
Weight	0.40Kg
Applicable Model	Please see "Accessory Selection"

PFA131

Dimensions (mm)

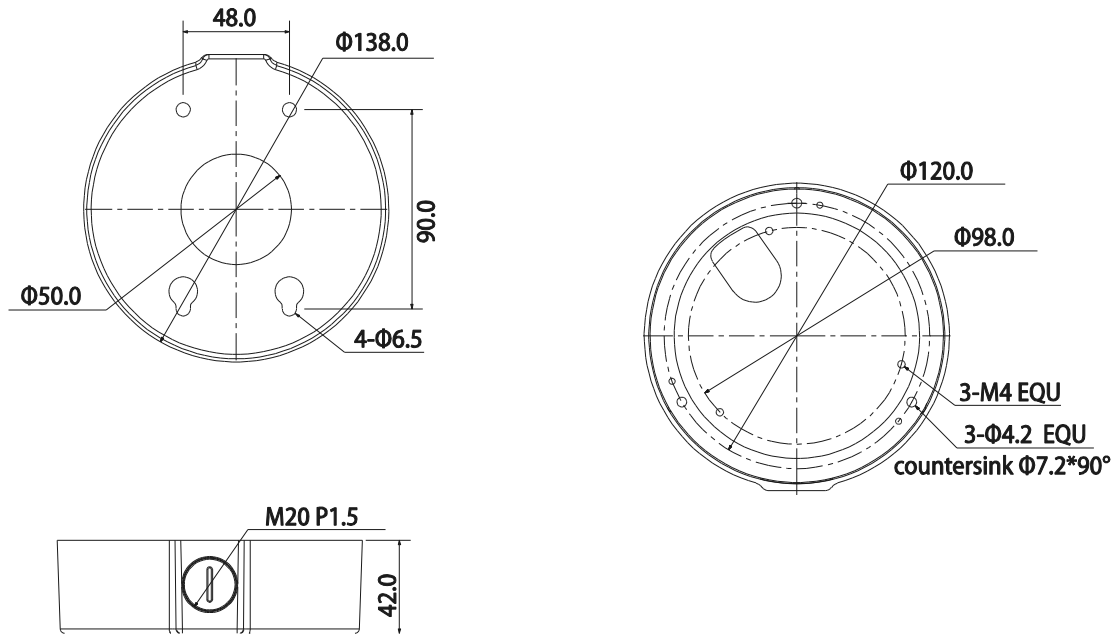

Application

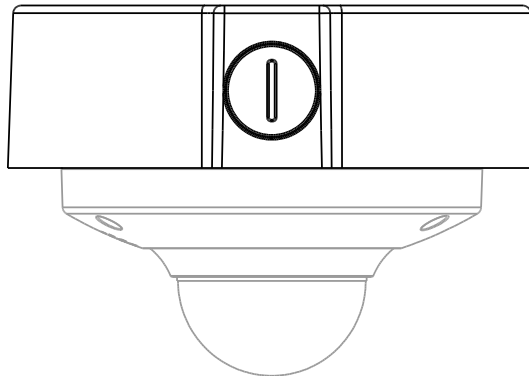

Dahua Technology Co., Ltd.

1199 BinAn Road, Binjiang District, Hangzhou, China

Tel: +86-571-87688883

Fax: +86-571-87688815

Email: overseas@dahuatech.com

www.dahuasecurity.com

*Design and specifications are subject to change without notice.

© 2013 Dahua Technology Co., Ltd.